

Description : PARADE L3 MC RECESSED

Code : AL5257

Scale : 1:6

SHEET 1 OF 2

Revision : 01

DIMENSIONS ARE IN MILLIMETERS [BRACKETED DIMENSIONS ARE IN INCHES]

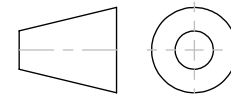

GRIVEN 

<http://www.griven.com>

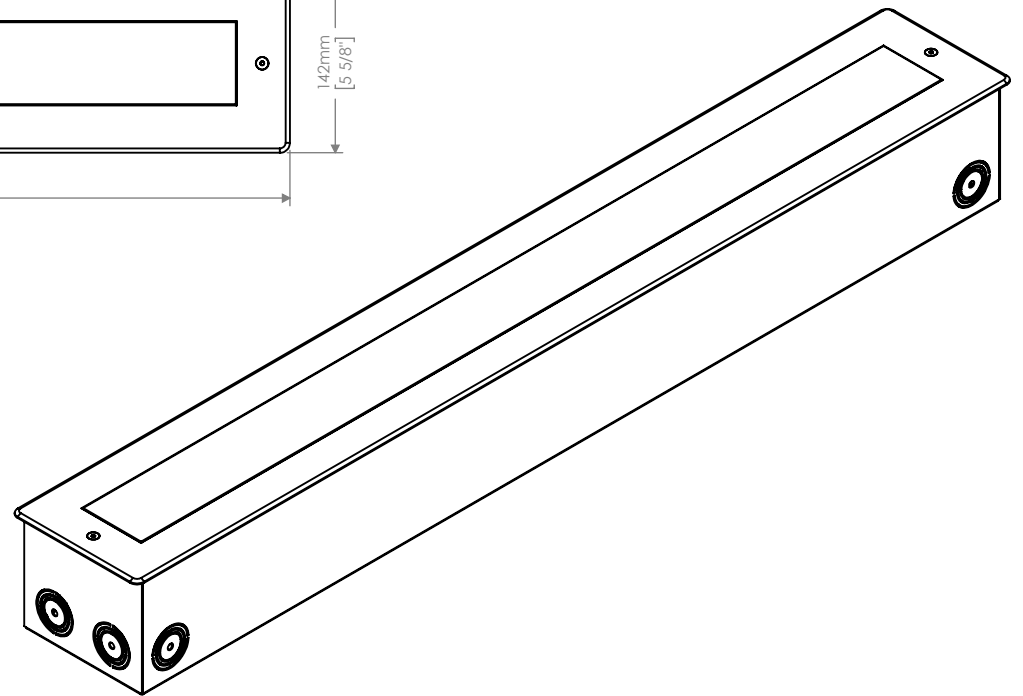
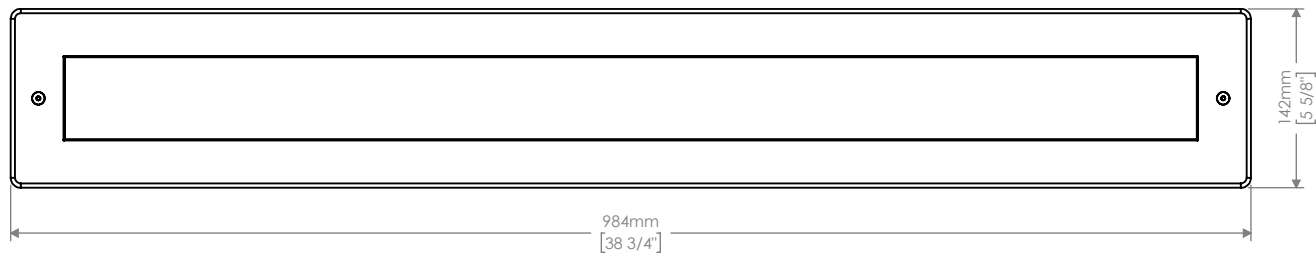
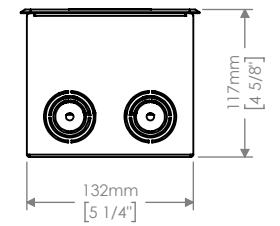
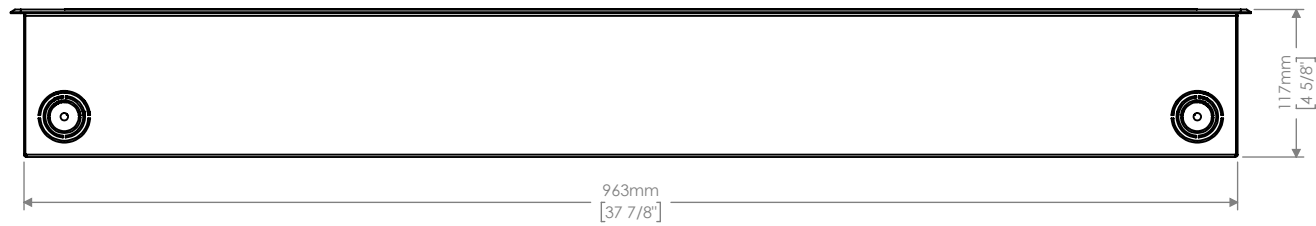

Description : PARADE L3 MC RECESSED

Code : AL5257

Scale : 1:6

SHEET 2 OF 2

Revision : 01

DIMENSIONS ARE IN MILLIMETERS [BRACKETED DIMENSIONS ARE IN INCHES]

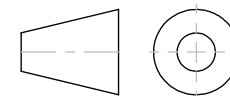

GRIVEN 

<http://www.griven.com>